

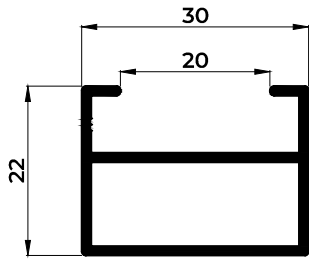

## LAMAS PARASOL



**01020**

MARCO DE 30

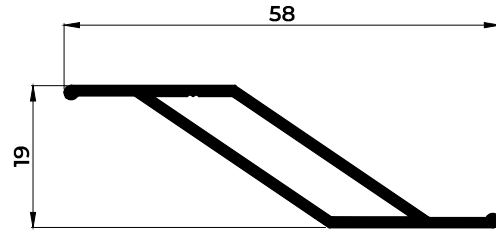

**01023**

LAMA TUBULAR FIJA

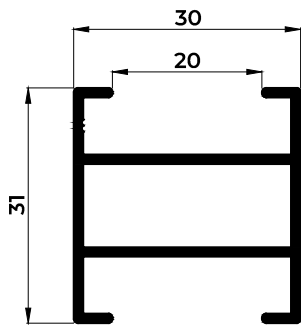

**01021**

PILASTRA

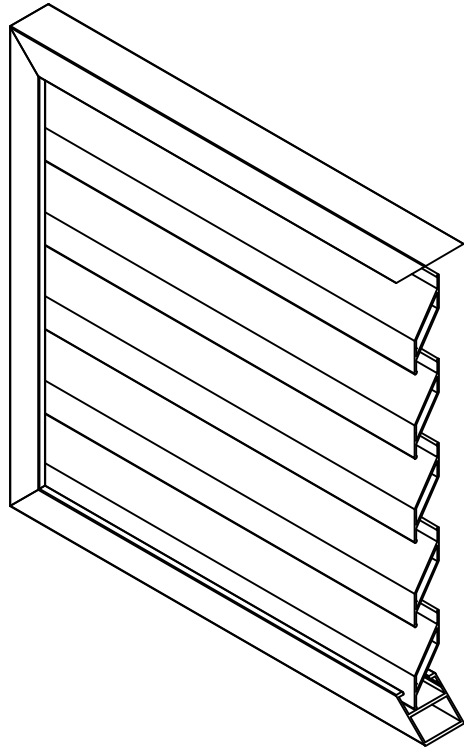

**25431**

ESCUADRA MALLORQUINA  
FIJA 3-2710-C (01020)



**25380**

SOPORTE LAMA FIJA  
(01020)

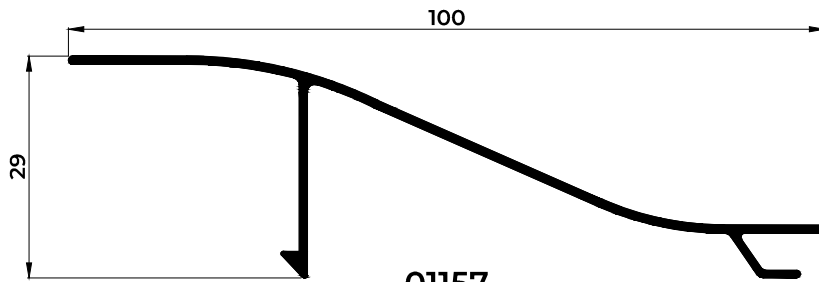

01157

LAMA FIJA DE 100 CURVA

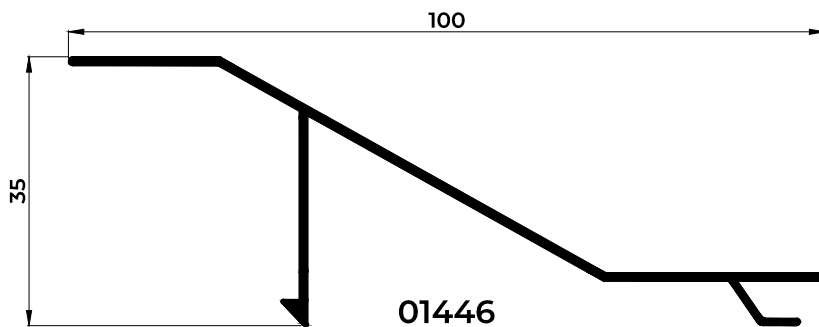

01446

LAMA FIJA DE 100 RECTA

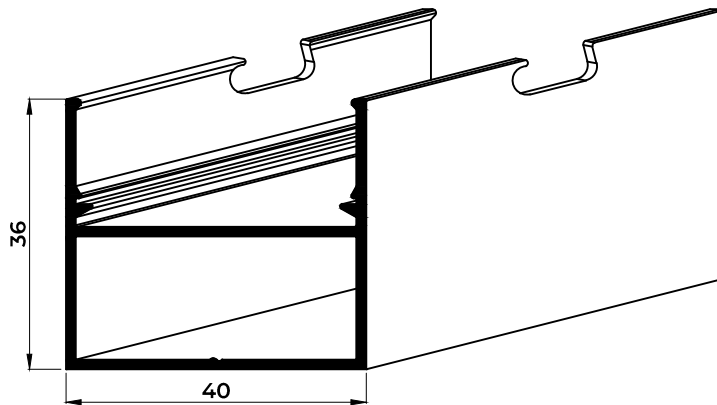

01053

MARCO LISO VENTANA TROQUELADO

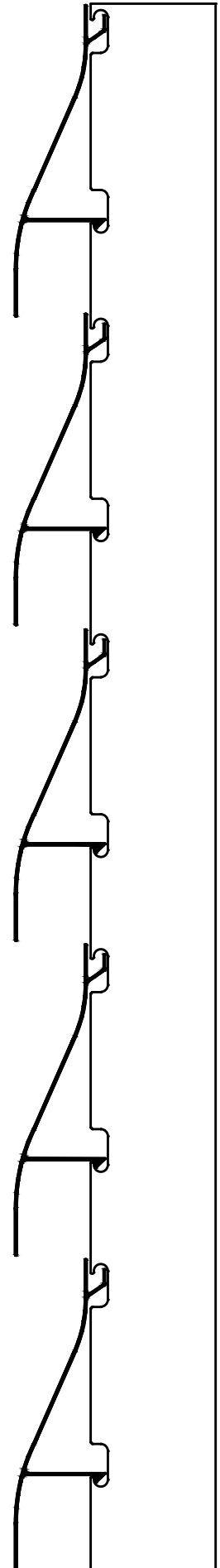



# LAMAS PARASOL

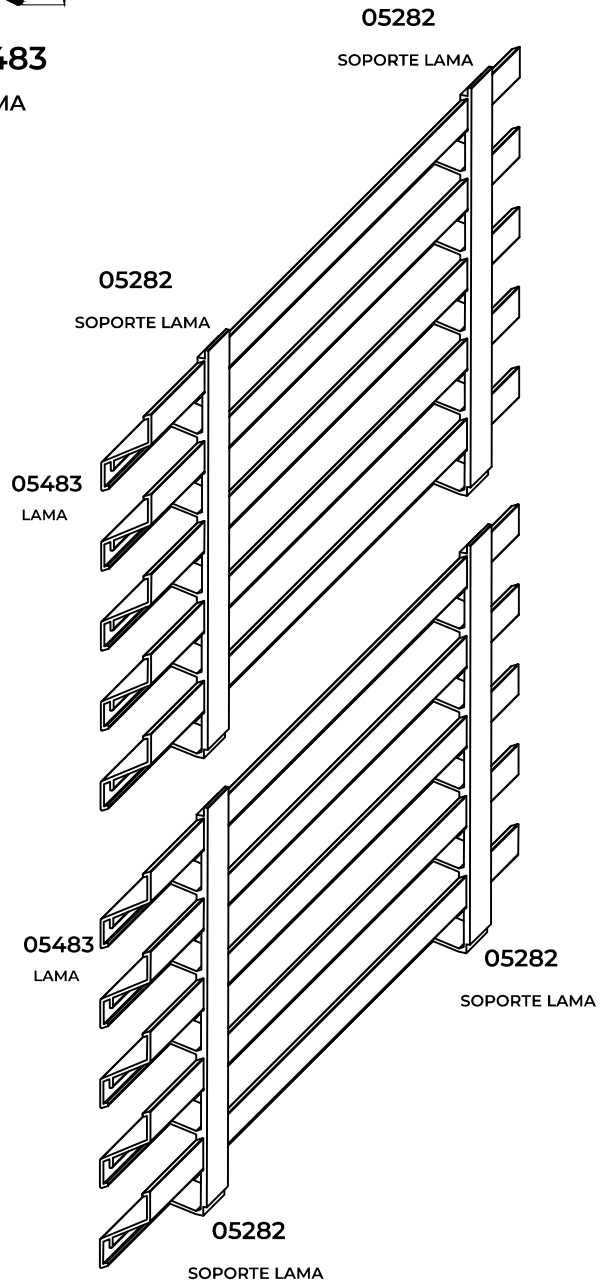
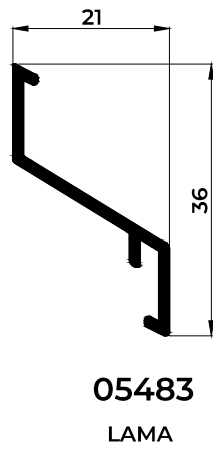
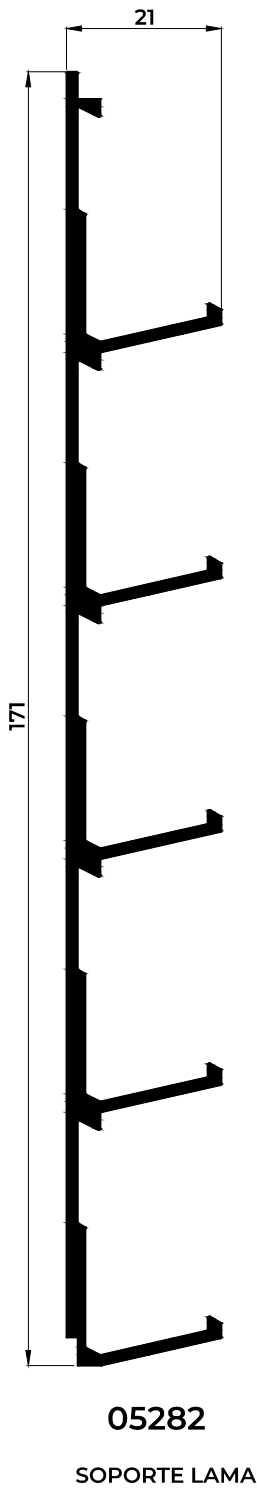



# LAMAS PARASOL

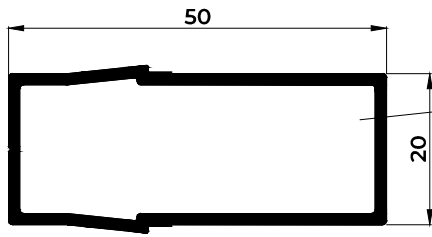

**01253**  
LAMA 50X20

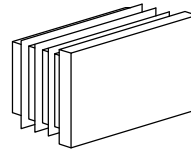

**27074**  
CONTERA 50X20

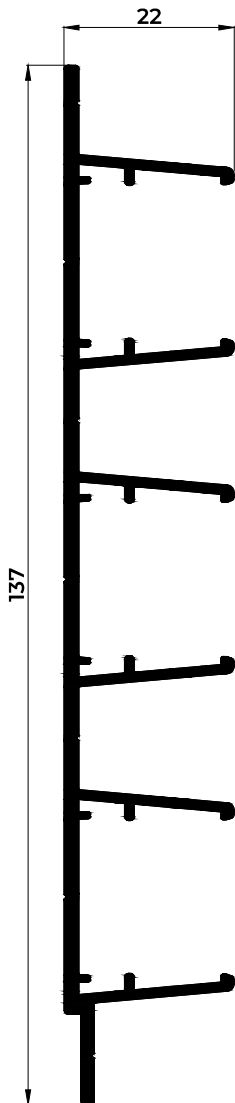

**01254**  
SOPORTE LAMA

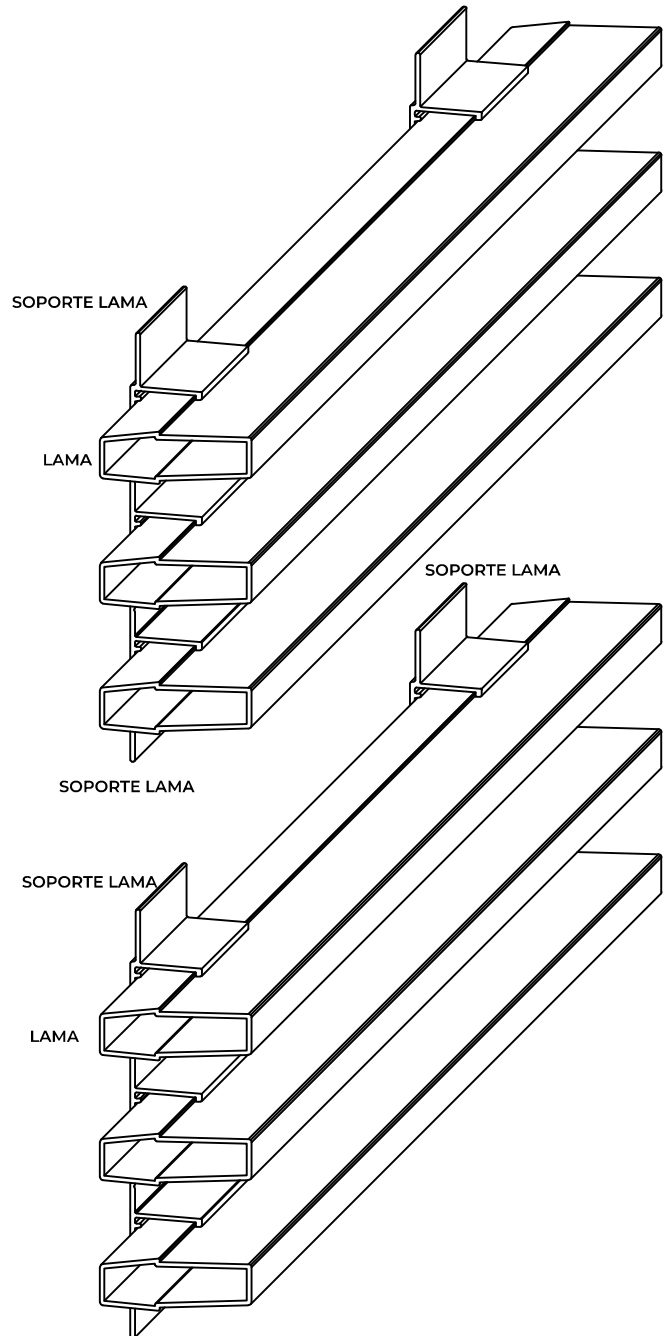

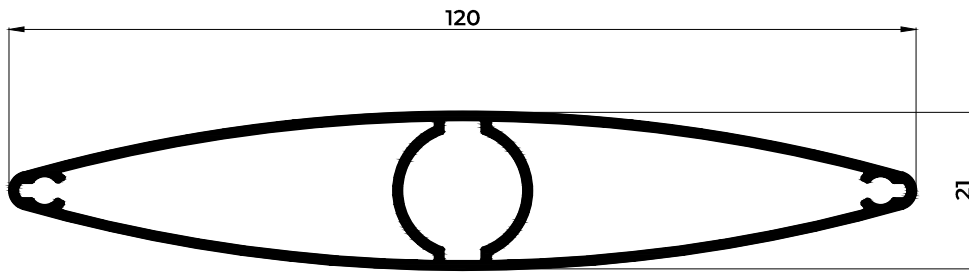

**01250**

LAMA REGULABLE DE 120  
(ACCESORIO DISPONIBLE)

## MEDIDAS DE MONTAJE LAMA REGULABLE DE 120 (01250)

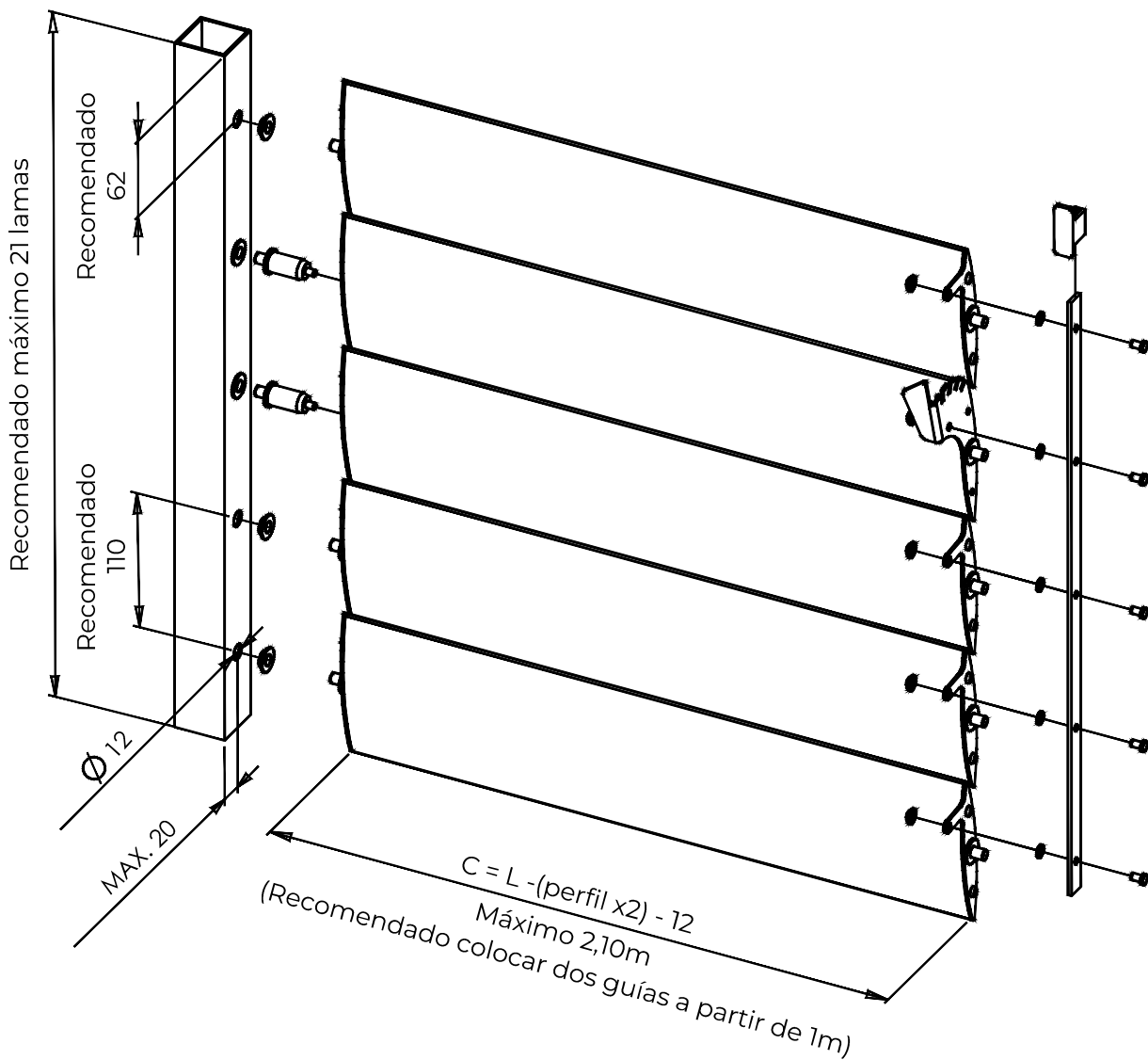

\* Entran 9 lamas en 1m

## KITS LAMA REGULABLE DE 120 (01250)

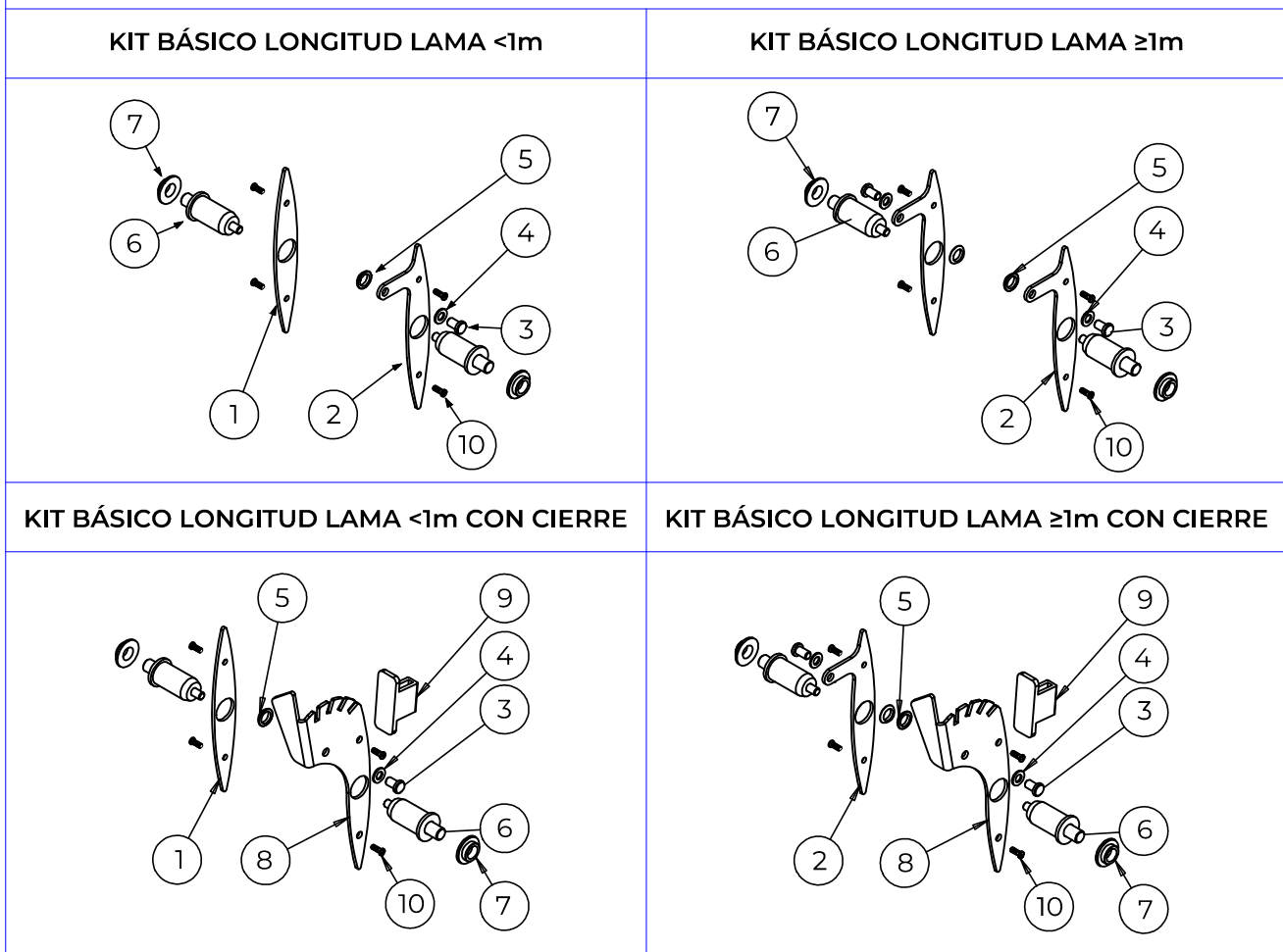

			CANTIDADES	
	REFERENCIA	DESCRIPCION	LONGITUD LAMA <1m	LONGITUD LAMA ≥1m
1	<b>27300</b>	TAPA LAMA	N x 1	
2	<b>27301</b>	TAPA LAMA PLETINA	(N x 1) - 1	(N x 2) - 1
3	<b>27306</b>	REMACHE	N x 1	N x 2
4	<b>27312</b>	ARANDELA 1mm	N x 1	N x 2
5	<b>27341</b>	ARANDELA 5mm	N x 1	N x 2
6+7	<b>27340</b>	EJE RETRACTIL CON ANILLO	N x 2	N x 2
8	<b>27302</b>	MANDO DERECHA	1	1
	<b>27342</b>	MANDO IZQUIERDA		
9	<b>27308</b>	FIJADOR	1	1
10	<b>27374</b>	TORNILLO 4,2x16 INOX	N x 4	N x 4
	<b>27307</b>	PLETINA 14x3 MECANIZADO 110mm	1 *	2 *

N = Número de lamias

\* Las cantidades de la tabla hacen referencia a los trozos que hay que cortar.  
Las barras de pletina se sirven a 6,5m.



# LAMAS PARASOL

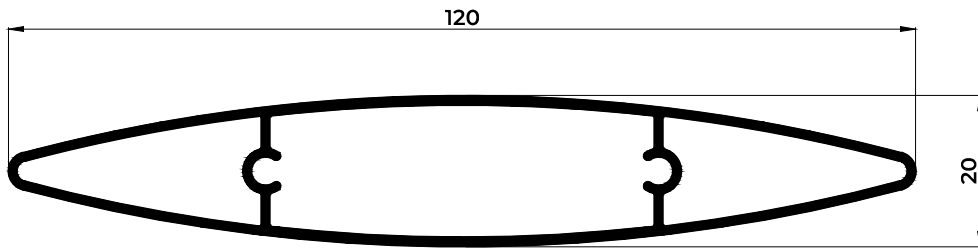

**01252**  
LAMA OVAL DE 120

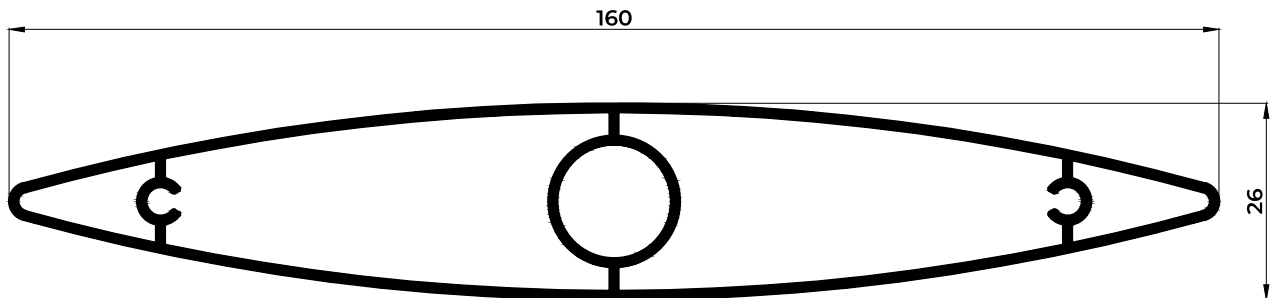

**01251**  
LAMA REGULABLE DE 160  
(ACCESORIO DISPONIBLE)

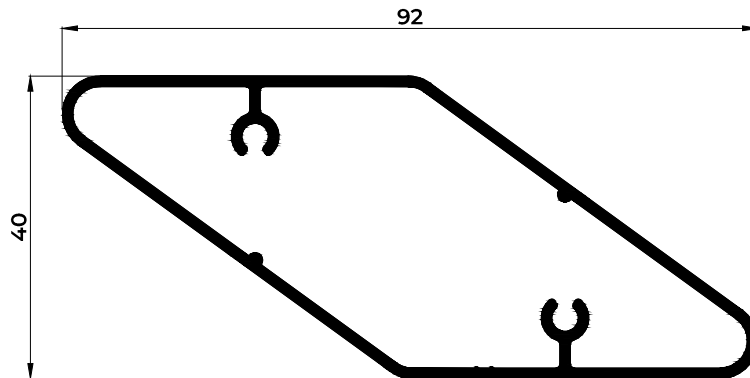

**01357**  
LAMA DE 92  
PORTATORNILLOS

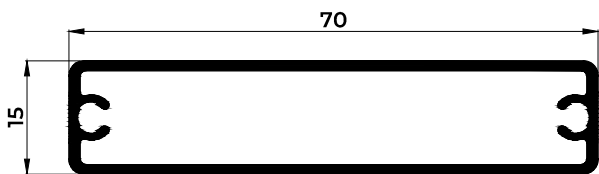

**01258**  
TUBO 70X15 PORTATORNILLOS

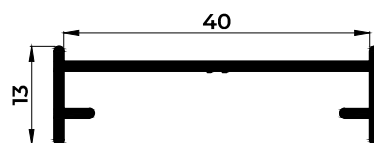

**01256**  
SOPORTE DE 40 PARA LAMA