

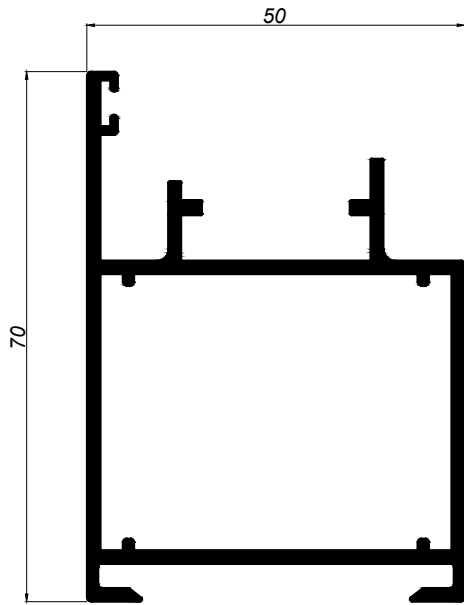

SERIE MARINA
PUERTA ENRASADA
DE 50

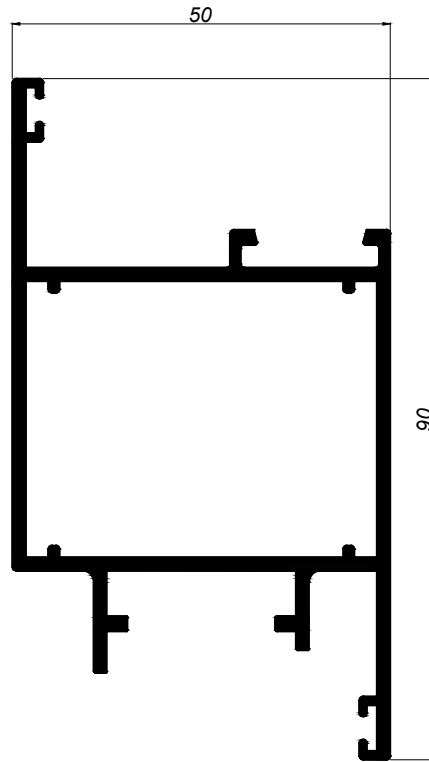

50050
MARCO PUERTA



50051
HOJA APERTURA INTERIOR

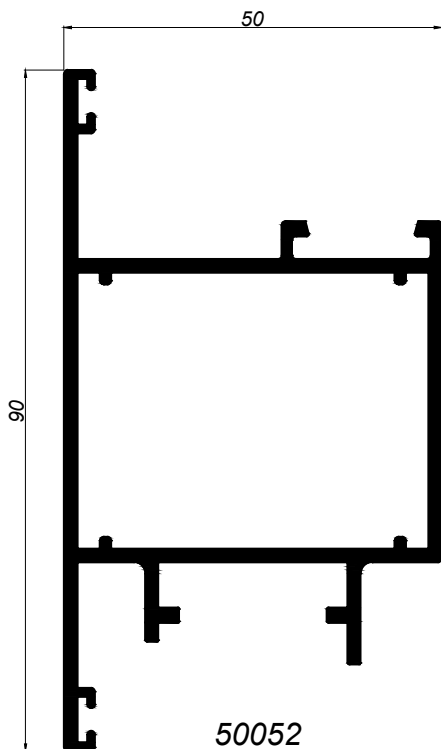

50052
HOJA APERTURA EXTERIOR

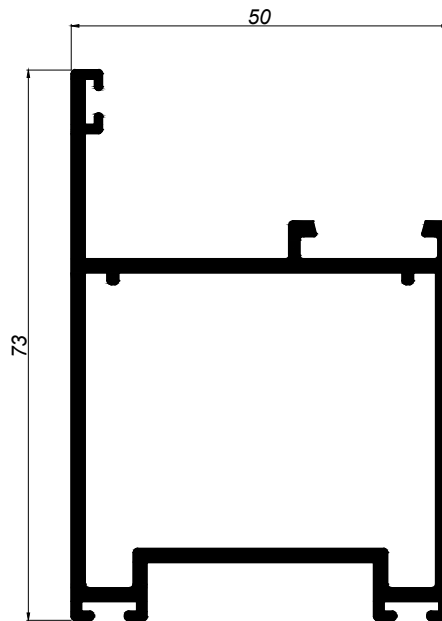

50165
HOJA VAIVEN

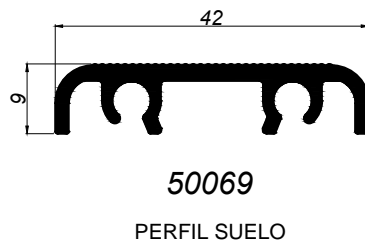
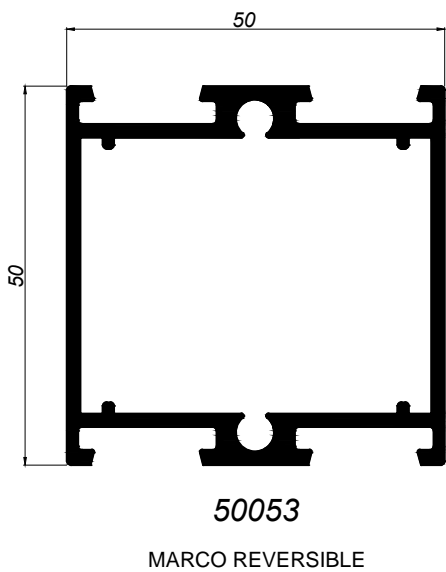
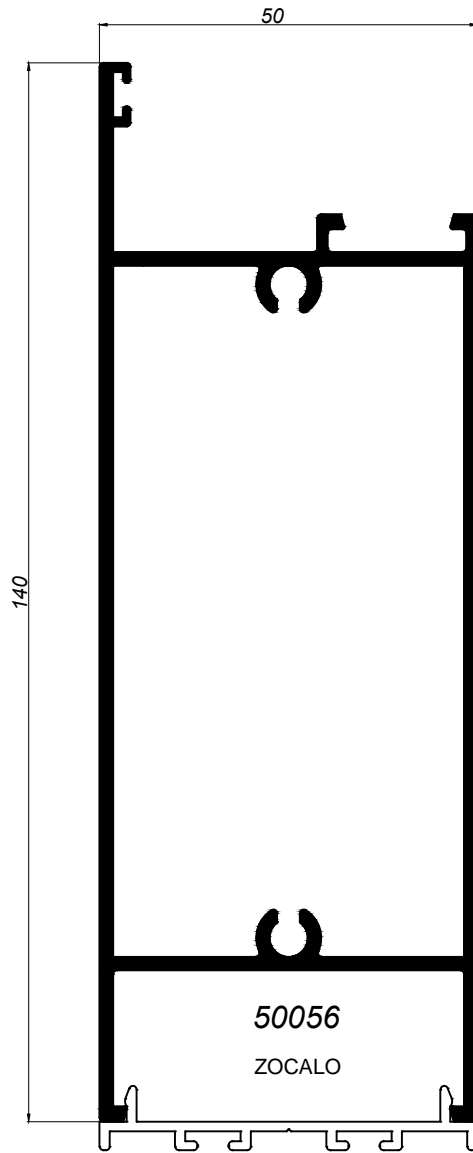
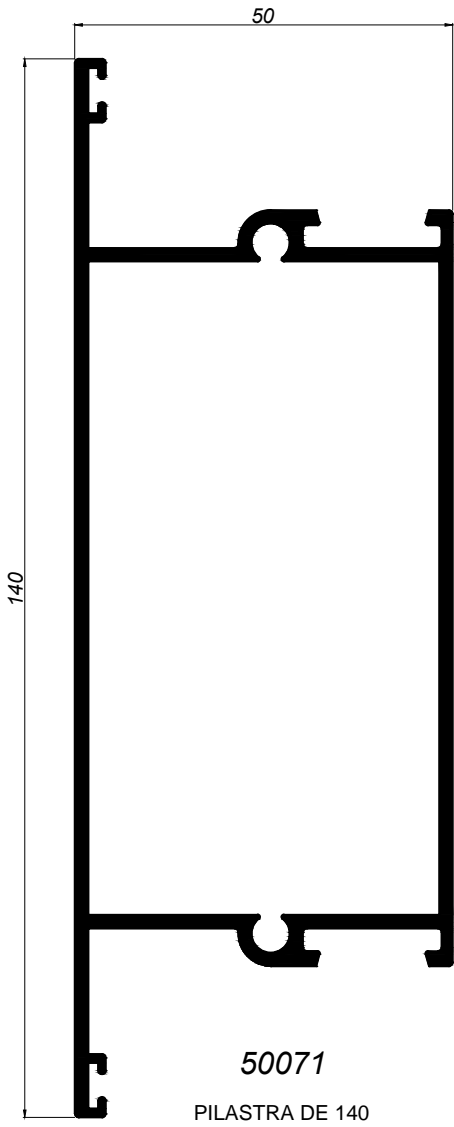

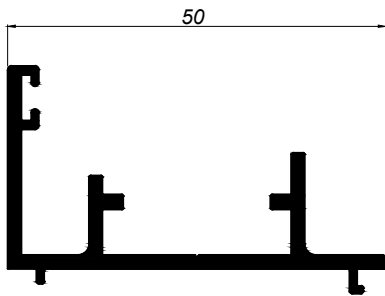

50066
SUPLEMENTO

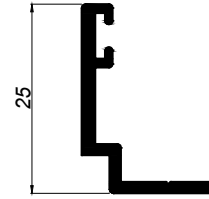

50055
BATIENTE FIJO

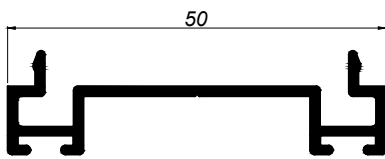

50067
SUPLEMENTO PARA FELPUDO

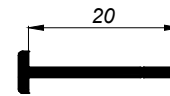

34008
UNION DE MARCOS

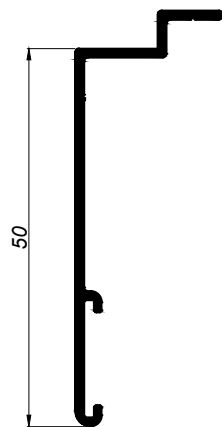

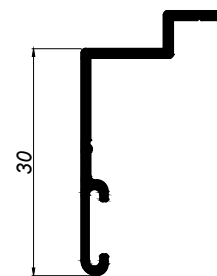

61772
SOLAPE ESCALON DE 50



61764
SOLAPE ESCALON DE 30

HUECOS DE ACRISTALAMIENTO

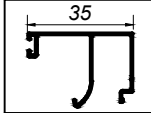
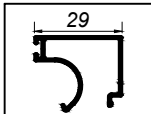
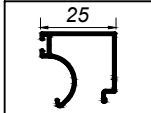
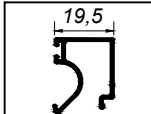
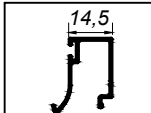
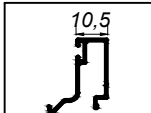
A

11	 47142
17	 47135
21	 47121
26.5	 47132
31.5	 47122
35.5	 47129
43	 47243

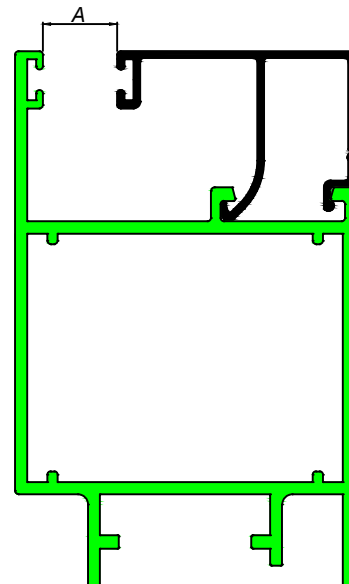







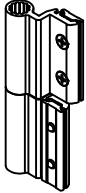
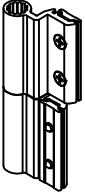
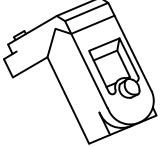
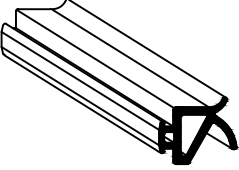

* CONSULTAR PEDIDO MÍNIMO

** Los valores de los huecos de acristalamiento son valores nominales. En la elección del hueco de acristalamiento habrá que tener en cuenta las tolerancias de los perfiles, de las juntas de acristalamiento y del vidrio.

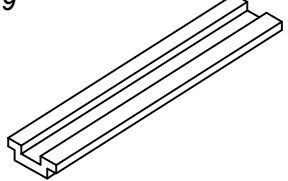
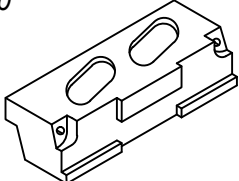
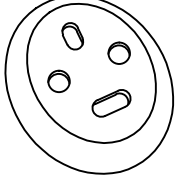
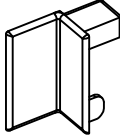
Se recomienda no seleccionar un junquillo que deje un hueco cuyo valor nominal se aproxime demasiado al espesor del vidrio.

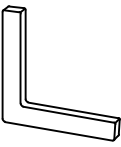
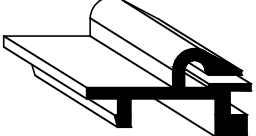
Accesorios

<p>26819</p>  <p>Bisagra dcha.</p>	<p>26820</p>  <p>Bisagra izqda.</p>	<p>26257</p>  <p>Escuadra puerta.</p>
<p>26271</p>  <p>Junta estanqueidad marco y hoja.</p>	<p>26665</p>  <p>Tirador.</p>	<p>27153</p>  <p>Pasador 450 mm.</p>
<p>27191</p>  <p>Pasador 140 mm.</p>	<p>26679</p>  <p>Pletina falleba 400 mm.</p>	<p>26260</p>  <p>Cerradero superior.</p>
<p>26261</p>  <p>Cerradero inferior.</p>	<p>26272</p>  <p>Tapón remate hoja.</p>	<p>25373</p>  <p>Unión puerta.</p>
<p>25336</p>  <p>Escuadra de alineación metálica para solapes.</p>	<p>25391</p>  <p>Grapa junquillo curvo.</p>	<p>25670</p>  <p>Escuadra junquillo curvo.</p>
<p>27159 Cerradura 1 pto (184/35/6U)</p> <p>27161 Cerradero 1 pto (CE184/1NRS)</p>		
<p>27160 Cerradura 3 ptos (296/35/6UV)</p> <p>27162 Cerradero central (CE196/1NRS)</p> <p>27163 Cerradero alto/bajo (CE296S/1NRS)</p>		