

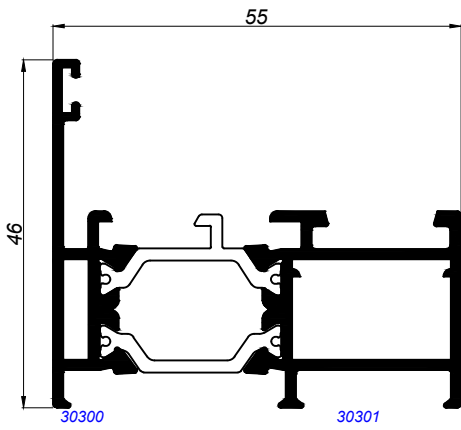

**SERIE MARINA**  
**PRACTICABLE**  
**RPT-55-60**

---



**66500**

MARCO VENTANA

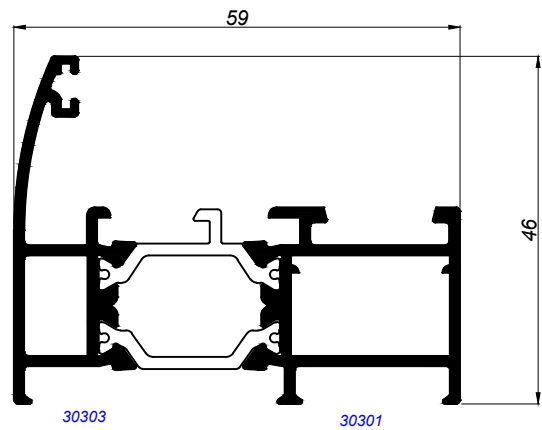

**66502**

MARCO VENTANA CURVO

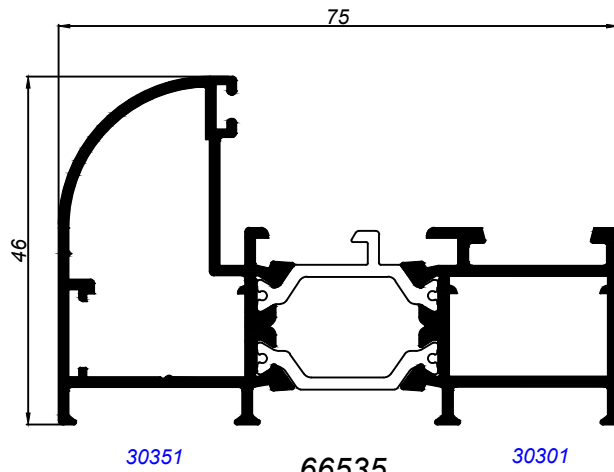

**66535**

MARCO CURVO DE 75

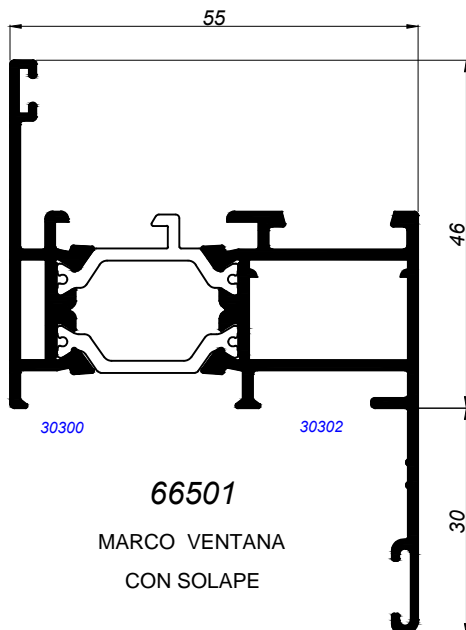

**66501**

MARCO VENTANA  
CON SOLAPE

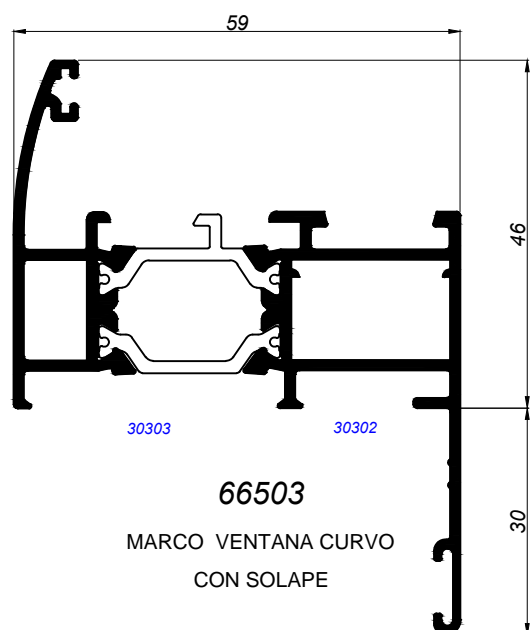

**66503**

MARCO VENTANA CURVO  
CON SOLAPE

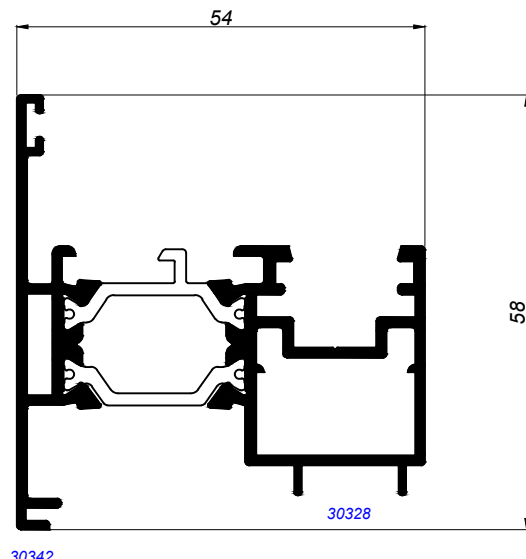
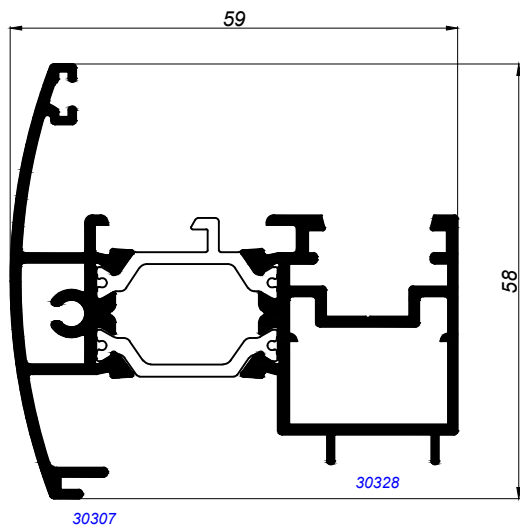
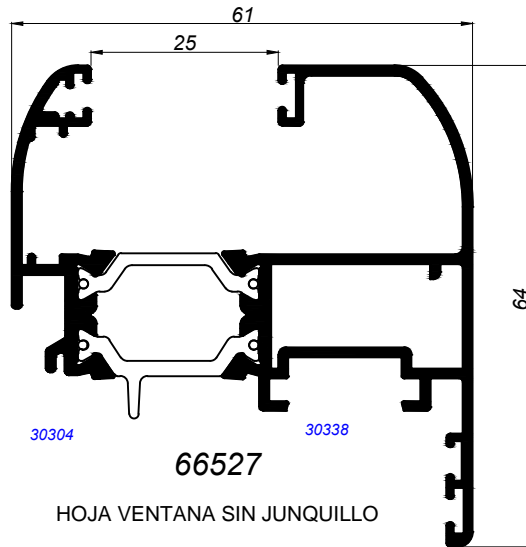
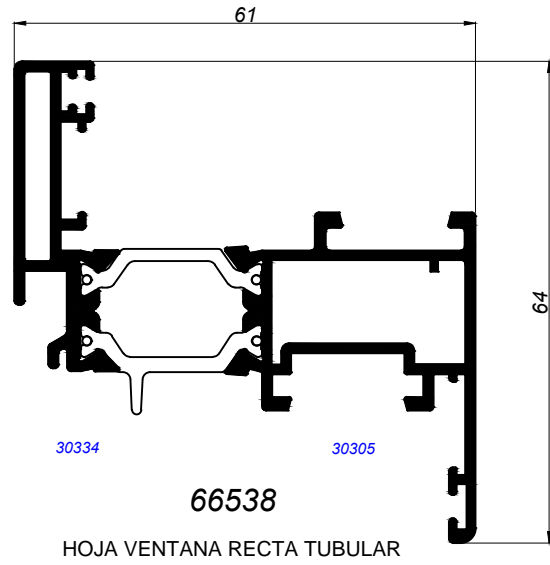
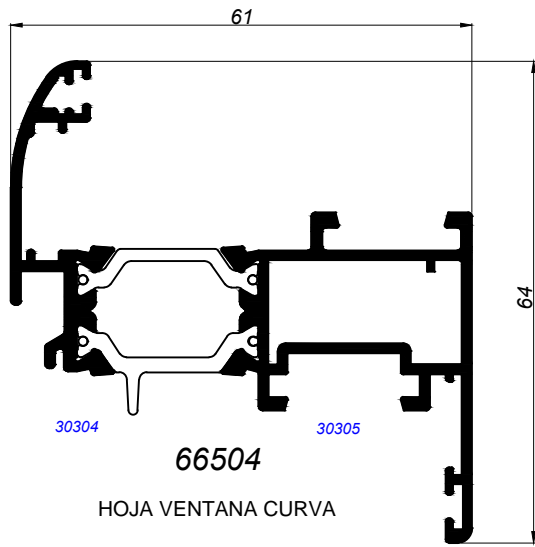

**66506**  
INVERSOR CURVO

**66546**  
INVERSOR RECTO

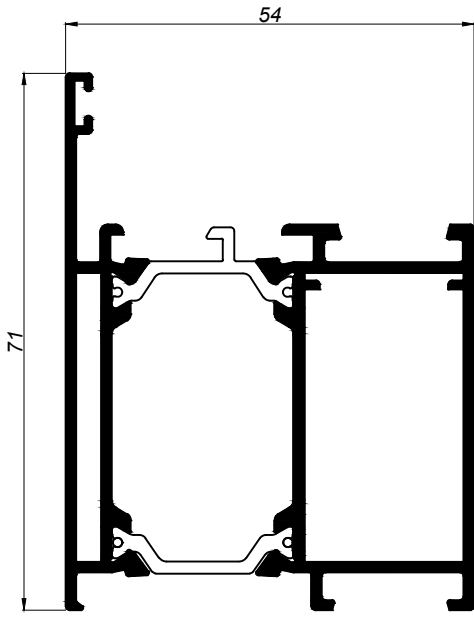

30411 30312

**66608**

MARCO PUERTA

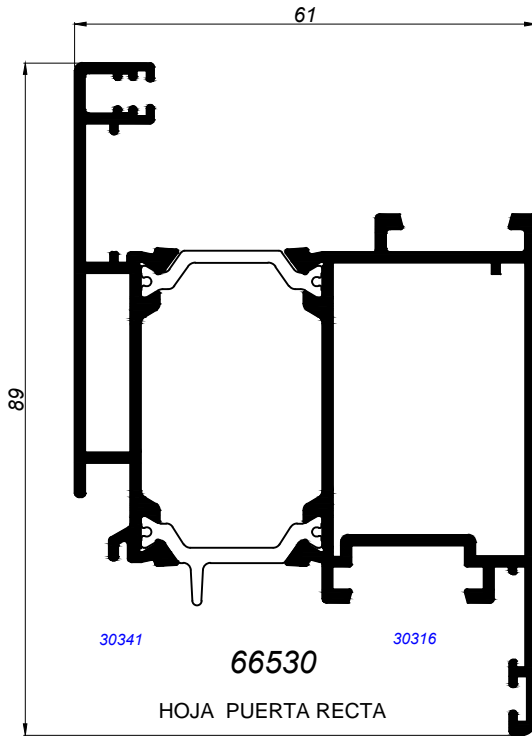

30341 30316

**66530**

HOJA PUERTA RECTA

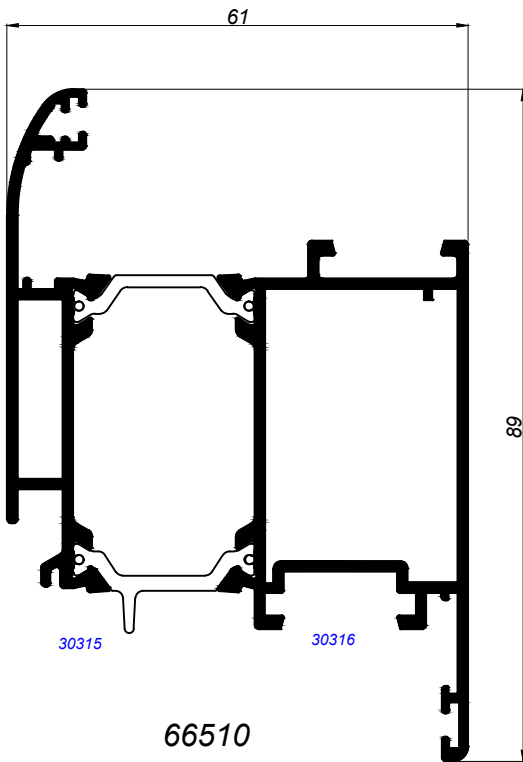

30315 30316

**66510**

HOJA PUERTA CURVA

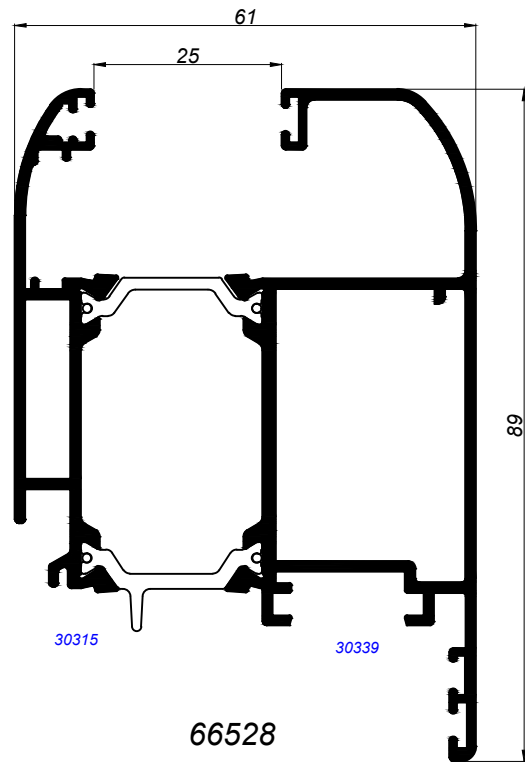

30315 30339

**66528**

HOJA PUERTA SIN JUNQUILLO

\* CONSULTAR PEDIDO MÍNIMO

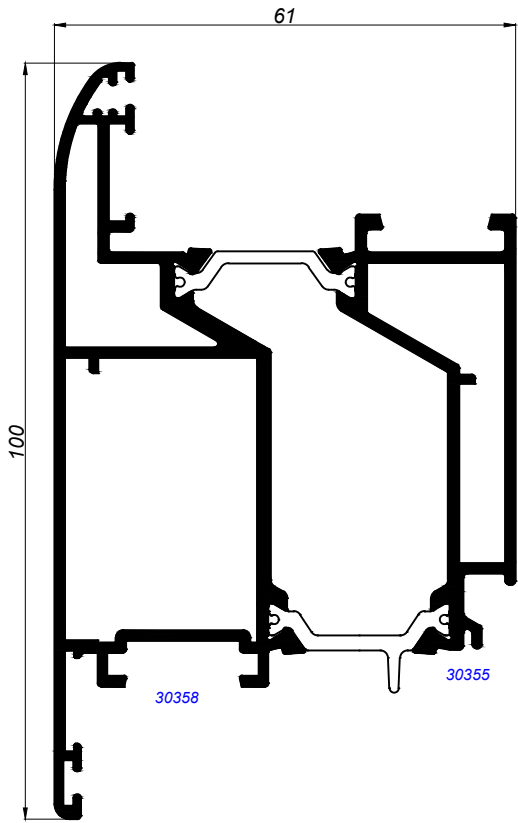

**66543**

HOJA APERTURA EXTERIOR CURVA

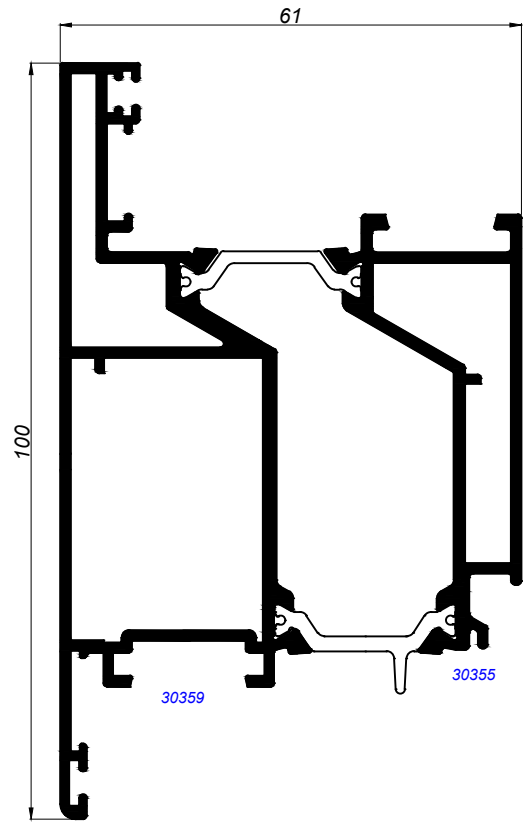

**66544**

HOJA APERTURA EXTERIOR RECTA

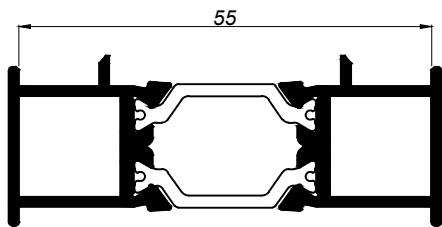

**66521**

UNION DE MARCOS DE 55

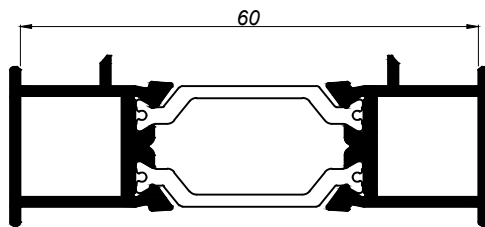

**66525**

UNION DE MARCOS DE 60

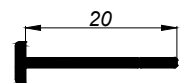

**34008**

UNION DE MARCOS

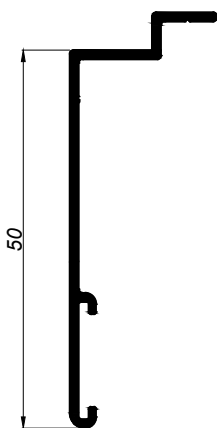

**61772**

SOLAPE ESCALON DE 50

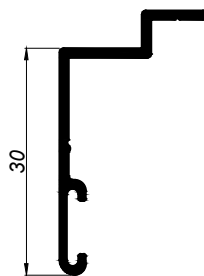

**61764**

SOLAPE ESCALON DE 30

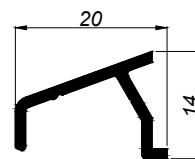

**45117**

VIERTEAGUAS



**42106**

PLETINA FALLEBA

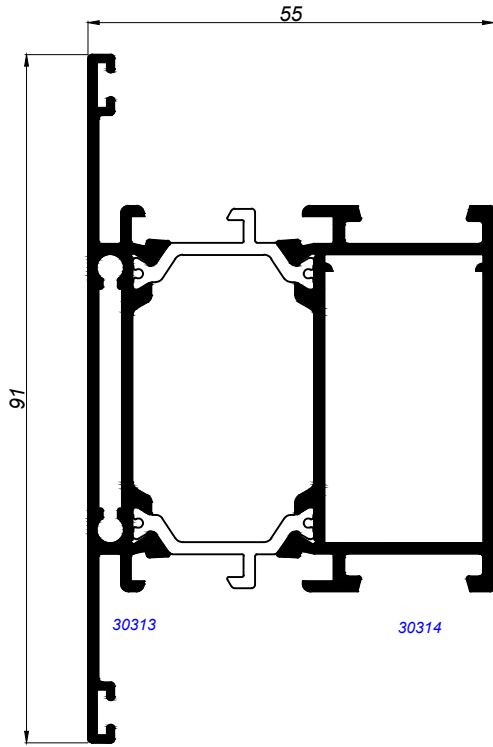

**66509**  
PILASTRA PUERTA

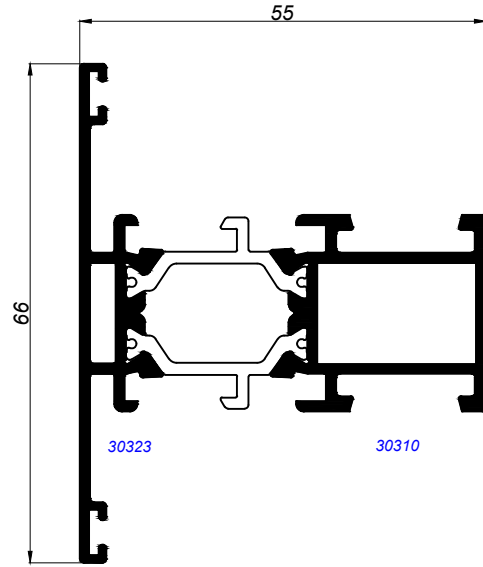

**66520**  
PILASTRA VENTANA

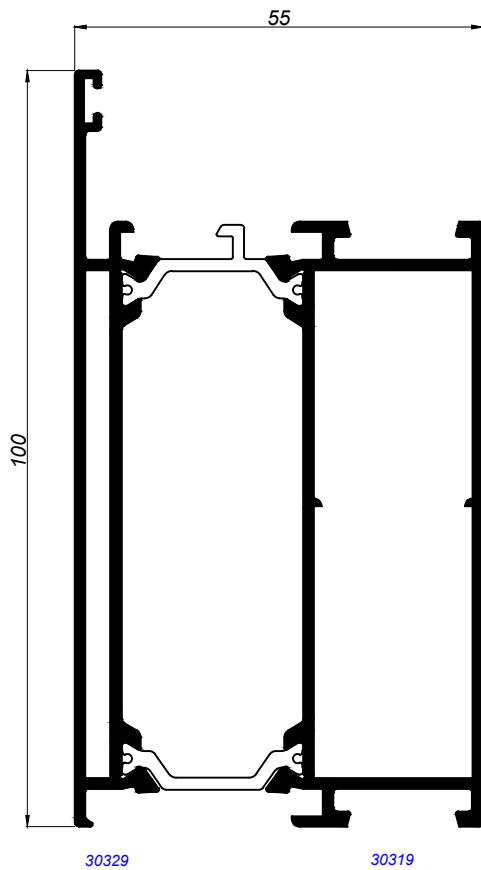

**66519**  
MARCO ZOCALO DE 100

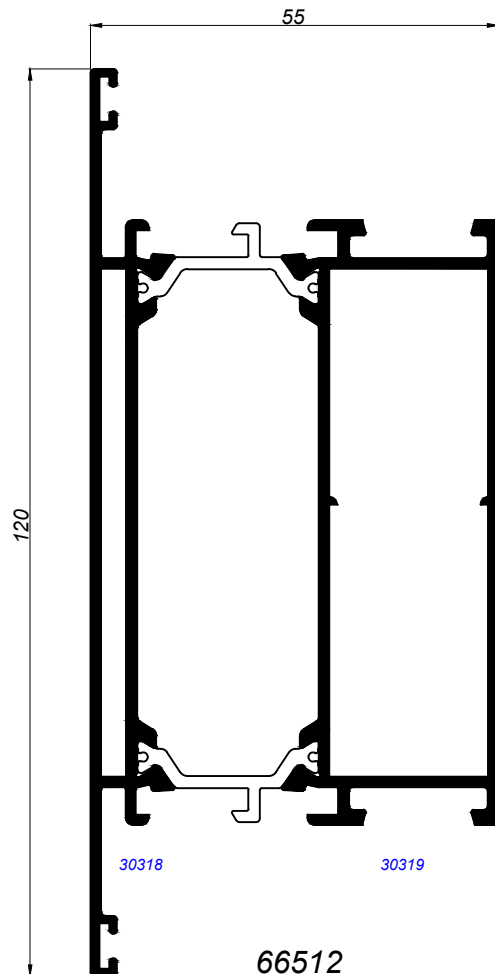

**66512**  
PILASTRA ZOCALO DE 120

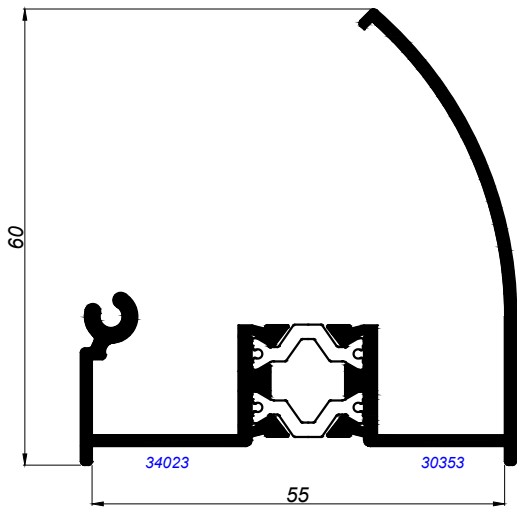

**66539**

MACHO ESQUINERO REGULABLE DE 55

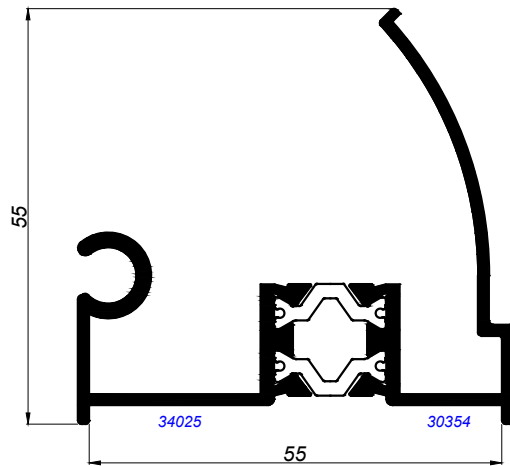

**66540**

HEMBRA ESQUINERO REGULABLE DE 55

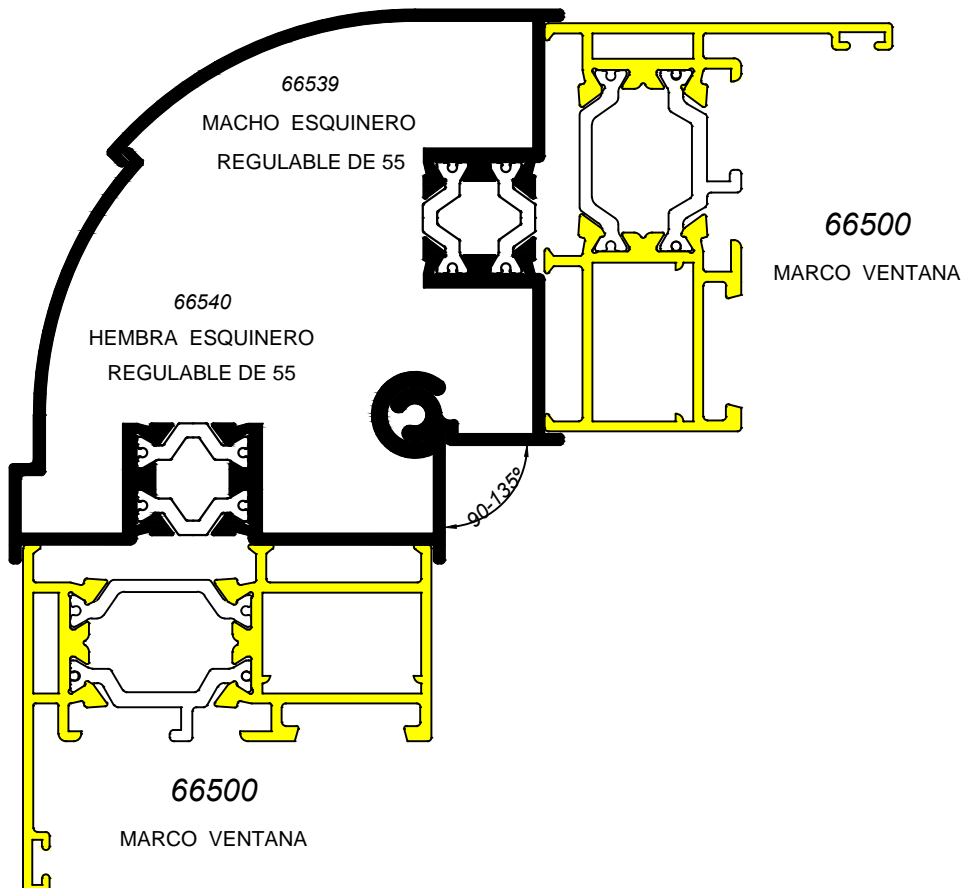

HUECOS DE ACRISTALAMIENTO

A

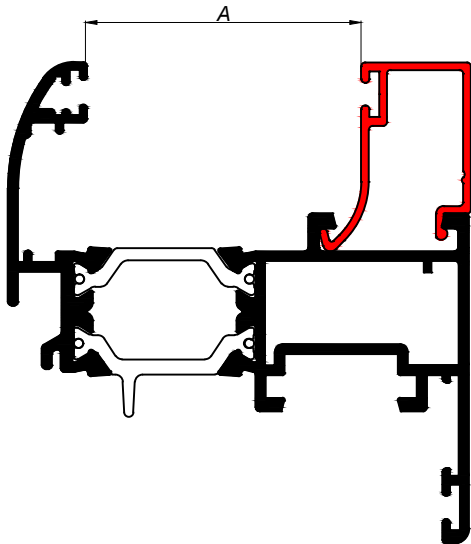

10.5				
15.5				
16.5				
21.5				
25.5				
31				
36				
40				
47.5				







\* CONSULTAR PEDIDO MÍNIMO

\*\* Los valores de los huecos de acristalamiento son valores nominales. En la elección del hueco de acristalamiento habrá que tener en cuenta las tolerancias de los perfiles, de las juntas de acristalamiento y del vidrio.

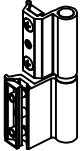

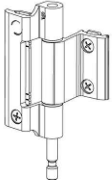
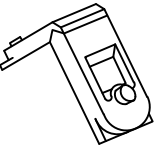
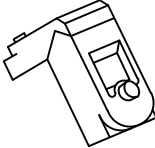
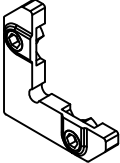
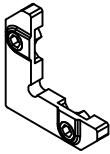

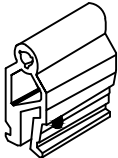
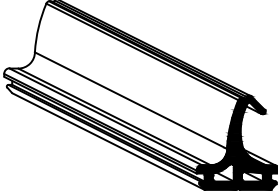
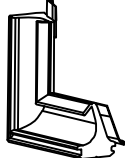
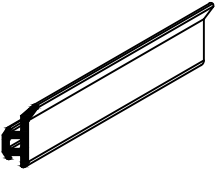
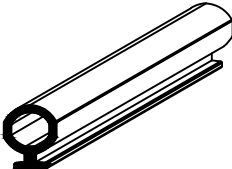
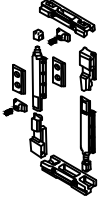
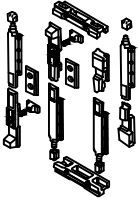
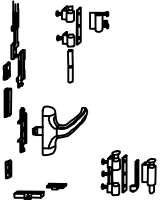
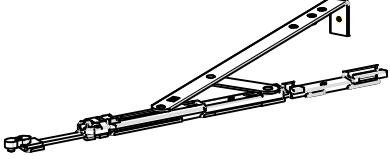
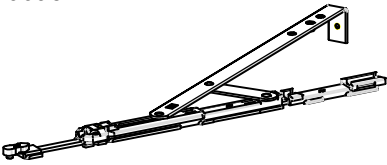
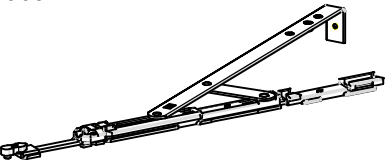
Se recomienda no seleccionar un junquillo que deje un hueco cuyo valor nominal se aproxime demasiado al espesor del vidrio.

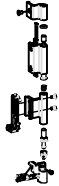
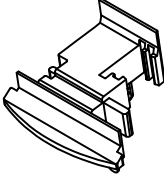
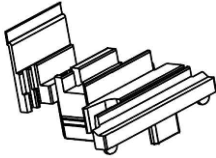
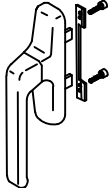
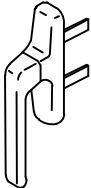

## Accesorios

<p>26751</p>  <p>Bisagra derecha.</p>	<p>26752</p>  <p>Bisagra izquierda.</p>	<p>26733</p>  <p>Bisagra 3 nudos.</p>
<p>25855</p>  <p>Escuadra ventana.</p>	<p>25856</p>  <p>Escuadra puerta.</p>	<p>25968</p>  <p>Escuadra alineación metálica FUJI 2007.</p>
<p>26429</p>  <p>Escuadra alineación metálica FUJI 2013. (Sólo para hoja 66538)</p>	<p>25476</p>  <p>Escuadra alineación metálica hoja.</p>	<p>25237</p>  <p>Unión tubular ventana.</p>
<p>25148</p>  <p>Unión puerta.</p>	<p>25857</p>  <p>Junta central marco.</p>	<p>27072</p>  <p>Ángulo junta central marco.</p>
<p>25977</p>  <p>Junta 2º marco.</p>	<p>26940</p>  <p>Junta hoja.</p>	<p>26695</p>  <p>Kit pasador CE 1 hoja.</p>
<p>26696</p>  <p>Kit pasador CE 2 hojas.</p>	<p>26709</p>  <p>Kit oscilobatiente.</p>	<p>26734</p>  <p>Oscilobatiente, compás micro (345-700).</p>
<p>26693</p>  <p>Oscilobatiente, compás pequeño (442-750).</p>	<p>26694</p>  <p>Oscilobatiente, compás grande (570-1200).</p>	<p>26725</p>  <p>Pasador 2ª hoja palanca.</p>

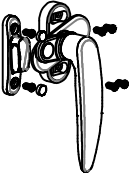
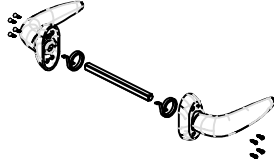
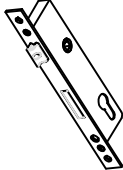
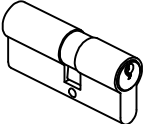
## Accesorios

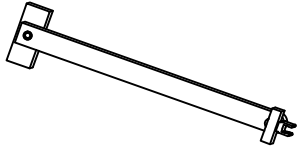
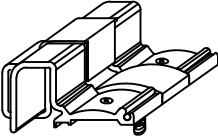
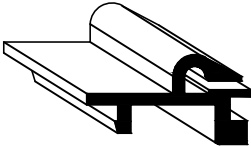
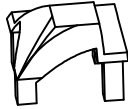
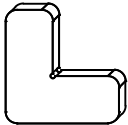
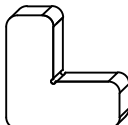
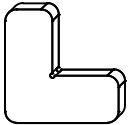
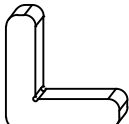
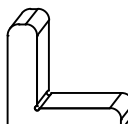
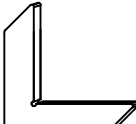
<p>26710</p>  <p>Bisagra 2ª hoja simétrica.</p>	<p>25470</p>  <p>Tapa inversor curvo RPT-55-60.</p>	<p>26726</p>  <p>Tapa inversor recto RPT-55-60.</p>
<p>26711</p>  <p>Cremona practicable.</p>	<p>26768</p>  <p>Cremona apertura exterior.</p>	<p>26769</p>  <p>Pernio apertura exterior.</p>
<p>25482</p>  <p>Cierre presión rodillo nylon.</p>	<p>25059</p>  <p>Manilla c/escudo recup. (juego).</p>	<p>25779</p>  <p>Cerradura.</p>
<p>25761</p>  <p>Cilindro.</p>	<p>25617</p>  <p>Cerradero C.E.</p>	<p>25786</p>  <p>Compás cámara europea.</p>
<p>25785</p>  <p>Golpete cámara europea.</p>	<p>25391</p>  <p>Grapa junquillo curvo.</p>	<p>25670</p>  <p>Escuadra junquillo curvo.</p>
<p>26418</p>  <p>Escuadra alineación hoja apertura exterior.</p>	<p>26419</p>  <p>Escuadra alineación hoja puerta.</p>	<p>26420</p>  <p>Escuadra alineación marco puerta.</p>
<p>26422</p>  <p>Escuadra alineación marco ventana.</p>	<p>26421</p>  <p>Escuadra alineación marco ventana curvo.</p>	<p>26716</p>  <p>Escuadra alineación interior hoja.</p>